

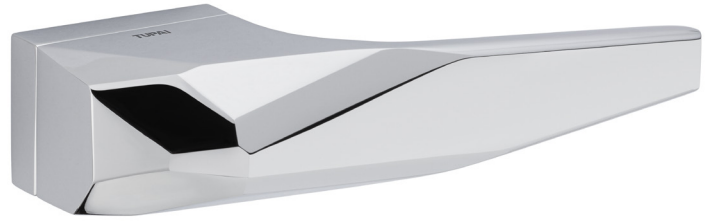

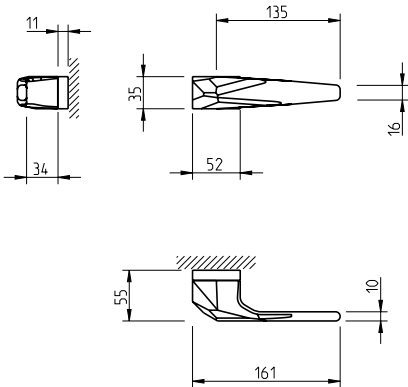



# REF. 4003 RE



-   
**(03)**  
 cromado brilhante  
 bright chrome
-   
**(96)**  
 cromado satinado  
 satin chrome
-   
**(141)**  
 titânio  
 titan
-   
**(142)**  
 níquelado pérola  
 nickel pearl
-   
**(153)**  
 preto pérola  
 black pearl
-   
**(158)**  
 purist brass  
 purist brass

## Descrição

Puxador par  
 Adaptador com sistema "click"  
 Mola recuperadora  
 Ferro quadrado de 8x100mm  
 Fixação da muleta com perno M6 oculto

## Description

Lever set  
 Mechanism with "click" system  
 Recovery spring  
 8x100mm square spindle  
 Handle fixed by a M6 grub screw

## Matéria Prima

Latão CW617N

## Raw Material

Brass CW617N

## Aplicação

Portas interiores com 30mm - 45mm espessura

## Application

Interior doors with 30mm - 45mm thick

## EN 1906

2	7	-	0	0	4	0	B
---	---	---	---	---	---	---	---

(acabamentos / finishes 03 - 153)

2	7	-	0	0	3	0	B
---	---	---	---	---	---	---	---

(acabamentos / finishes 141 - 142 - 158)

3	7	-	0	0	4	0	B
---	---	---	---	---	---	---	---

(acabamentos / finishes 96)