

IT EN FR ES P D NL PL GR RUS

WINDOW HINGE

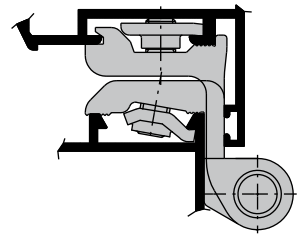

Art. 9826B

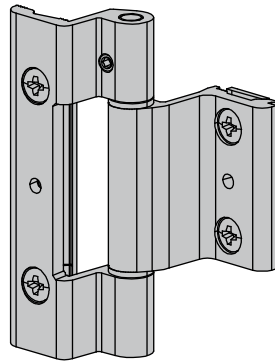

fapim[®]

Life in evolution

ULDK - Rev.00

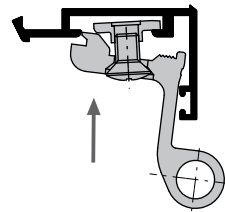
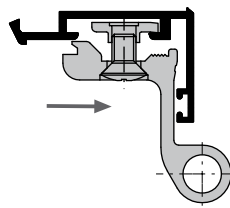
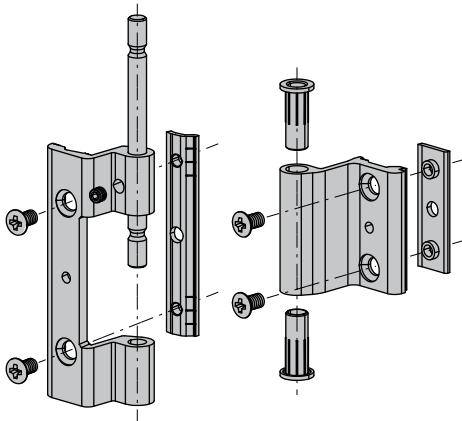



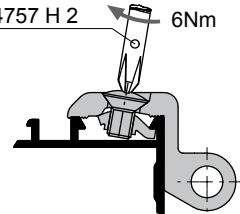
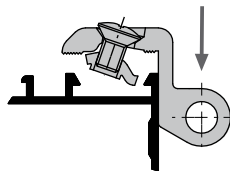



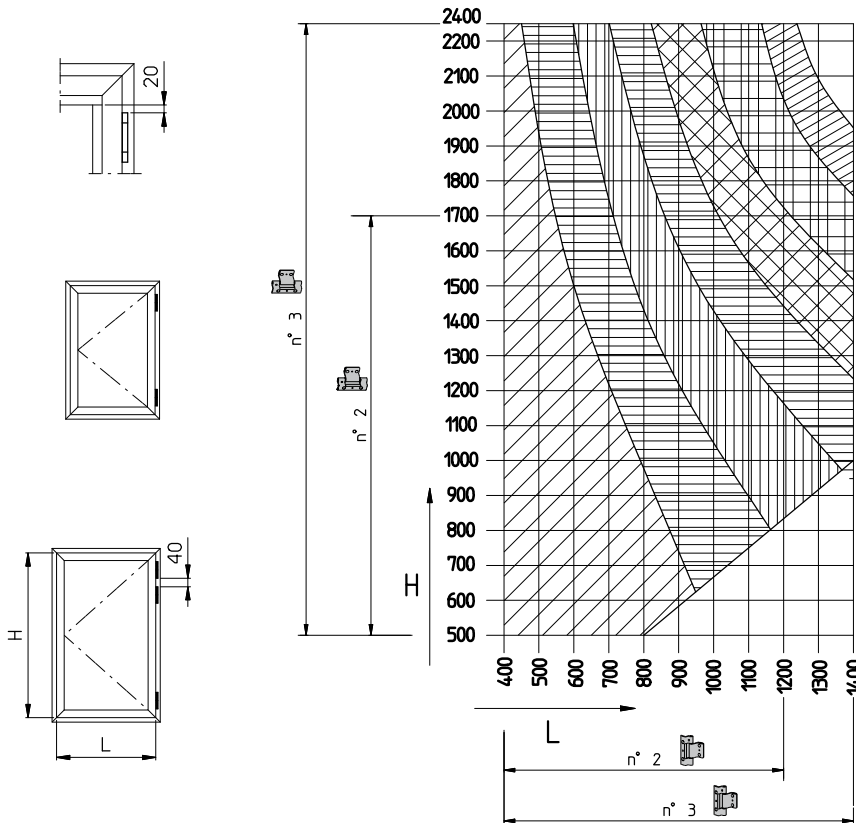

UNI EN ISO 4757 H 2 6Nm



LIMITI D'USO LIMIT OF UTILIZATION LIMITE DE UTILIZATION BENUTZUNGSGRENZE LIMITACION DE UTILIZACION
 GEBRUIZSLIMIET LIMITES À UTILIZAÇÃO ORGANICZENIA ZASTOSOWANIA ΠΕΡΙΟΡΙΣΜΟΙ ΧΡΗΣΗΣ



	Kg/m ²	N° 
	20	n° 3
	30	n° 3
	20	n° 2
	40	n° 3
	30	n° 2
	50	n° 3
	40	n° 2
	60	n° 3
	50	n° 2
	70	n° 3
	60	n° 2
	80	n° 3
	70	n° 2